

DESIGNING WITH ENGINEERING

PLASTICS

with survey tables

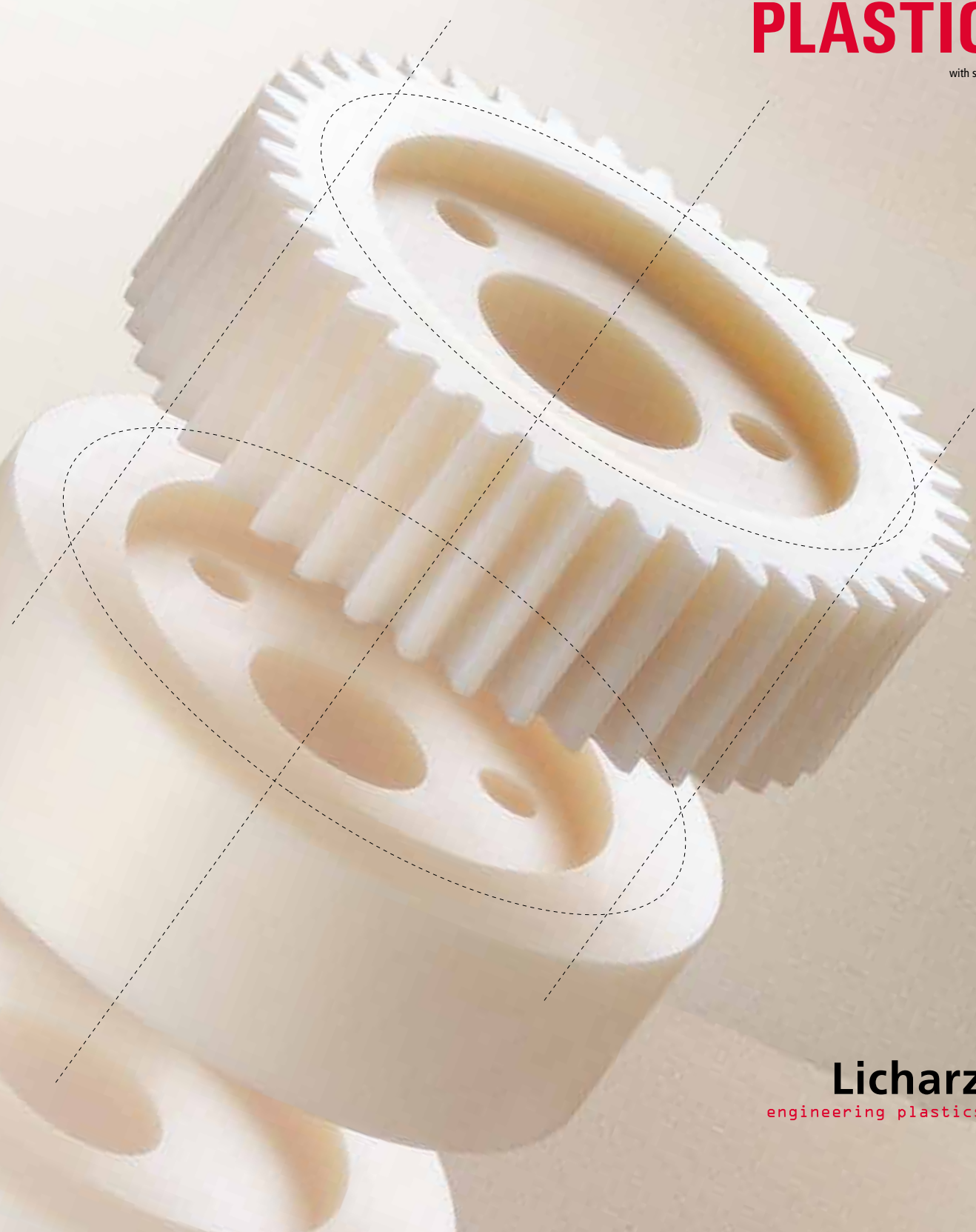



LICHARZ

MACHINING AND POST-MACHINING PROCESSES

The competitive edge through engineered components made of plastic

1. Machining of thermoplastics

With the increasing variety of engineering plastics and the resulting applications, design engineers now have many new horizons that were previously unthinkable with conventional materials. In many cases, in addition to material limitations, the only other limits to design possibilities are the restrictions imposed by the manufacturing process. Particularly if large volume parts are required from cast polyamides and polyacetal (POM) or polyethylene terephthalate (PET), manufacturing processes such as injection moulding cannot be used.

This applies equally to complex parts that require machining from all sides with narrow tolerances.

Fig. 1: Complex component made from POM



In this area, machining has proven to be the best method. Highly precise parts and large components can be manufactured especially economically in small and medium batches by machining.

For the manufacture of high quality products, certain specific features of plastics must be considered when machines and tools are being chosen and used.

1.1 Machining equipment/tools

No special machines or processes are required for machining. The machines that are normally used in the woodworking and metal industries with HSS tools (high speed steel) or hard metal tools can be used. The only thing to consider is that when a circular saw is used to cut plastic, hard metallic saw blades must be used.

The group of glass fibre reinforced plastics is a special case. While it is possible to machine them with hard metal tools, it is very difficult to achieve economic results due to the short service life of the tools. In this case it is advisable to use diamond tipped tools, which are much more expensive than conventional tools but have a much longer service life.

1.2 Machining and clamping the workpiece

Plastics have lower thermal conducting properties than metals, as well as a lower modulus of elasticity. If not handled properly, the workpiece can become extremely warm and thermal expansion can occur. High clamping pressures and blunt tools cause deformation during machining. Dimensional and shape deviations outside the tolerance range are the consequence. Satisfactory results are only achievable if several material-specific guidelines are considered when machining plastics.

Machining guidelines

Machining and post-machining processes

In detail, these guidelines are:

- The highest possible cutting speed should be chosen.
- Optimum chip removal must be ensured so that the chips are not drawn in by the tool.
- The tools that are used must be very sharp. Blunt tools can cause extreme heat, which results in deformation and thermal expansion.
- The clamping pressures must not be too high as this would result in deformation of the workpiece and the clamping tool would leave marks in the workpiece.
- Because of the low degree of stiffness, the workpiece must be adequately supported on the machine table and should lie as flat as possible.
- Perfect, high-quality surfaces can only be obtained when the machines operate with low vibration.

Particularly problematic to produce accurately are parts which require high cutting volumes or an uneven depth of cut. In both cases it is advisable to make a preliminary cut leaving an allowance and apply intermediate tempering. That and subsequent 24-hour storage ensure that machining-induced thermal stresses and residual stresses in the semi-finished product are largely relieved. The parts can then be finish machined.

If these guidelines are complied with, it is not difficult to obtain narrow, plastic-oriented tolerances with a high level of reproducibility.

1.3 Cooling during machining

As a rule it is not absolutely necessary to cool the workpiece during machining. If cooling is to be applied it is recommended that compressed air is used. This has the advantage that in addition to the cooling effect, the chips are removed from the working area and cannot be drawn into the workpiece or tool.

Common drilling emulsions and cutting oils can also be used for cooling. The application is particularly recommended when deep holes are to be introduced or a thread is to be cut. It also enables higher feed rates and therefore achieves lower run times. However, it must be kept in mind that some plastics may not be resistant to some ingredients of the drilling emulsions and cutting oils and can be irreversibly damaged. Therefore it is advisable to check the resistance of the plastic before use. Alternatively, the emulsion or oil manufacturers can provide information and advice on any known incompatibilities with plastics. Workpieces with emulsion or cutting oil on them should be thoroughly cleaned after machining. It is important to ensure that any residues are completely removed. This ensures that any follow-up operations such as gluing or painting remain trouble free. With polyamides particular care must be taken to prevent the water content of the emulsion from causing changes in the parts through moisture absorption.

2. Parameters for the individual machining processes

2.1 Sawing

Plastics can be sawn with a band saw or a circular saw. The choice depends on the shape of the semi-finished product. The use of a band saw is particularly recommended when a “support groove” (prism) is used to cut rods and tubes and also has the advantage that the heat is dissipated via the long saw blade. However, the teeth of the blade must be set adequately so that the blade cannot jam.

Circular saws, on the other hand, are mainly used for cutting sheets and blocks with straight edges. Here, attention should be paid that the feed rate is adequate so that chips are removed, that the saw blade does not jam and that the plastic does not overheat at the point where it is being cut. Table 1 contains guiding values for the cutting geometry of the saw blades.

2.2 Milling

Milling on conventional machining centres is unproblematic. With a high cutting speed and medium feed rate it is possible to achieve high levels of machining performance with good surface quality and accuracy. Care must be taken that tools with sufficiently large chip space are used. It guarantees a reliable chip removal and it avoids heat congestion. We recommend the values given in the Table in regard to the cutter geometry.

2.3 Turning on a lathe

Since most plastics produce unbroken chips, it is important to ensure that the chips are removed, as they would otherwise catch and revolve with the part being turned on the lathe. In addition, because of the low degree of stiffness of plastics, there is a great danger of longer parts sagging, and it is thus advisable to use a steady rest. The values given in the Table apply to the cutter geometry.

2.4 Drilling

Drill holes can be made with a conventional HSS drill. If deep holes are being drilled, it must be ensured that the chips are removed, as otherwise the plastic on the walls of the hole will heat to the point of melting and the drill will “clog”. This especially applies to deep holes. For drilled holes in thin-walled workpieces, it is advisable to choose a high drilling speed and, if applicable, a neutral (0°) effective cutting angle. This prevents the drill from sticking in the workpiece and hinders the associated stripping of the hole or the workpiece being drawn up by the drill. The recommended values for drill cutting geometry are shown in the table.

2.5 Drilling large diameters in sections of round rod

When drilling, high temperatures build up on the cutting edges, especially with highly crystalline materials such as **LINNOTAM**, which cannot be adequately dissipated because of the good insulation properties of the plastics. The heat causes an internal expansion in the material, which in turn causes compressive stress in the inside of the rod section. This stress can be so high that the rod tears and splits. This can be avoided to a great extent if the material is machined correctly.

Machining guidelines

Machining and post-machining processes

It is advisable to pre-drill the hole and complete it with a right side tool. The pre-drilled holes should not exceed 35 mm in diameter. Drilled holes in long sections of rod must only be made from one side, as otherwise an unfavourable stress relationship is created when the drilled holes meet in the middle of the rod, which can lead to the rod section cracking.

In extreme cases it may be necessary to heat the blank to approx. 120-50 °C and pre-drill it in this condition. The hole can then be completed when the rod has cooled down and when an even temperature has set in throughout the blank. Finishing can take place after complete cooling and achieving a uniform temperature level inside the blank.

2.6 Notes on reinforced and filled plastics

Plastics that are reinforced or filled with glass fibres, carbon fibres, glass beads, mineral substances or other substances have a higher level of residual stress compared to non-reinforced or unfilled plastics. The reinforcement and filler materials also make the products harder and more brittle and reduce impact strength. This makes these products susceptible to cracking. During machining the residual stresses may be relieved, which makes itself noticeable by strong deformation, cracking or full failure. The following notes should therefore be taken into account when machining and manufacturing:

- If possible the semi-finished products should be heated to approximately 120 °C before drilling or sawing. (Suggested exposure time: approx. 5-6 min per mm of cross-section).
- As a minimum a carbide-tipped, but preferably diamond-coated tools should be used for machining.
- When clamping and fixing ensure freedom from deformation and expose the material to the minimum possible bending, tensile or compressive forces.

If the above guidelines are observed the production of complex products from engineering plastics using machining processes can be easily achieved even where the highest quality standards of accuracy and functionality are required.

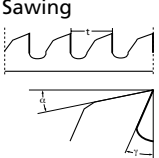
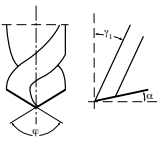
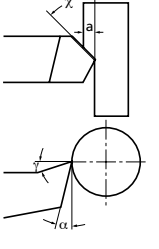
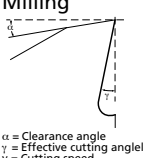
	PA	POM	PET	PE/PP-H	PVC	PVDF	PTFE	PSU	PEI	PEEK	Reinforced materials
Sawing  <p> α = Clearance angle (°) γ = Effective cutting angle (°) v = Cutting speed (m/min) t = Number of teeth Values for circular saw without () Values for band saw with () Use offset bandsaw blades! </p>											
α	30-40 (10-20)	30-40 (10-20)	30-40 (10-20)	20-30 (20-30)	5-10 (30-40)	30-40 (10-20)	10-15 (10-30)	10-15 (10-30)	10-15 (15-30)	10-15 (15-30)	15-30 (15-30)
γ	0-10 (0-8)	0-10 (0-8)	0-10 (0-8)	6-10 (2-8)	0-6 (0-5)	0-10 (0-8)	0-15 (0-4)	0-15 (0-4)	10-15 (15-30)	0-15 (0-5)	15-30 (10-15)
v	1000-3500 (200-1000)	1000-3500 (200-1000)	1000-3500 (200-1000)	1000-3500 (500-800)	3000-4000 (800-1200)	1000-3500 (200-1000)	1800-2000 (300-500)	1800-2000 (300-500)	1800-2000 (300-500)	1800-2500 (500-800)	500-1500 (200-300)
t	24-80 (3-5/inch)	24-80 (3-5/inch)	24-80 (3-5/inch)	24-80 (3-8/inch)	36-80 (3-5/inch)	24-80 (3-5/inch)	24-80 (2-5/inch)	24-80 (3-5/inch)	24-80 (3-5/inch)	24-80 (3-5/inch)	24-80 (3-5/inch)
Drilling  <p> α = Clearance angle (°) γ = Effective cutting angle (°) ϕ = Point angle (°) v = Cutting speed (m/min) s = Forward feed (mm/rev.) The angle of twist of the drill should be at least 12-16° </p>											
α	5-15	5-10	5-10	10-20	5-10	5-15	10-15	8-15	8-15	5-15	5-10
γ	5-10	5-15	5-15	10-15	0-5	5-20	5-20	10-20	10-20	10-15	5-10
ϕ	60-90	60-90	60-90	60-90	60-100	110-130	110-130	60-90	60-90	90-120	110-120
v	50-150	50-150	50-150	50-150	30-120	100-300	100-300	50-100	50-100	50-200	80-100
s	0.1-0.5	0.1-0.3	0.1-0.3	0.1-0.5	0.1-0.5	0.1-0.3	0.1-0.3	0.1-0.4	0.1-0.4	0.05-0.3	0.1-0.3
Turning on a lathe  <p> α = Clearance angle (°) γ = Effective cutting angle (°) ξ = Setting angle (°) v = Cutting speed (m/min) s = Forward feed (mm/rev.) a = Rate of cut (mm) The point radius should be at least 0.5 mm </p>											
α	5-15	5-10	5-10	5-10	8-10	5-15	5-10	5-10	5-10	5-10	6-8
γ	0-10	0-5	0-5	0-5	0-5	5-15	0-5	0-5	0-5	0-5	2-8
ξ	0-45	0-45	0-45	0-60	30-60	0-45	0-45	0-45	0-45	0-45	45-60
v	200-500	200-500	200-500	250-500	250-750	150-200	200-500	150-400	150-400	200-500	150-200
s	0.05-0.5	0.05-0.5	0.05-0.5	0.1-0.5	0.3-0.5	0.1-0.3	0.05-0.5	0.1-0.3	0.1-0.3	0.2-0.5	0.1-0.5
a	to 15	to 15	to 15	to 15	to 10	to 15	to 15	to 10	to 10	to 15	to 10
Milling  <p> α = Clearance angle (°) γ = Effective cutting angle (°) v = Cutting speed (m/min) Feed up to 0.5 mm per tooth Helix angle of the cutter from 0-40° </p>											
α	5-15	5-10	5-10	5-20	5-10	5-15	10-15	10-20	10-20	5-15	15-30
γ	0-15	0-10	0-10	5-15	0-15	5-15	15-20	5-15	5-15	5-10	5-10
v	to 1000	to 1000	to 1000	to 1000	to 1000	to 1000	to 600	to 400	to 400	to 500	to 100

Instructions for cutting: For the following dimensions/materials we recommend heating before making the cut: from Ø 50: PA 66 GF from Ø 60: PEEK-GF, PEEK-GL, POM-G from Ø 100: PA 6 GF, PA 12 GF, PE	Do not use lubricants/oils. Risk of tension cracks! Use of carbide and diamond tools is recommended Heat semi-finished products to approx. 120° C! Suggested exposure time: approx. 5-6 min per mm of cross-section
before drilling in the center: from Ø 60: PEEK-GF, PEEK-GL, POM-GF from Ø 80: PA 66 GF from Ø 100: PA 66, PA 6 GF, PA 12 GF, PET from Ø 180: L ^{IN} NOTAM, L ^{IN} NOTAM ^{Hi} PERFORMANCE 612, L ^{IN} NOTAM ^{Hi} PERFORMANCE 1200	

Machining guidelines

Machining and post-machining processes

3. Post-machining processes

3.1 Conditioning

The process of conditioning is defined as treatment of dry polyamide products aiming at the fastest possible moisture accumulation. This can be necessary where parts made from polyamides must not change dimensions due to further water absorption, where parts are to be in permanent contact with water or submerged in water, or where specific material changes should be brought about by water absorption.

Polyamide products are usually distinguished by the following moisture conditions:

- dry (moisture content <0.2%)
- humid (constant weight when stored in standard air at 23 °C/50% relative humidity)
- wet (constant weight even after prolonged immersion in water)

For conditioning, besides the processes that use warm air and humidity, it is also possible to store in hot water (water temperature approx. 80 °C-100 °C max). In terms of effort this is the simplest method, but it does have some significant disadvantages. With thick-walled parts the water first diffuses in the surface regions and saturates them. However, after the conditioning period the lower layers still do not have the desired water content. After removing the parts from the water bath a portion of the absorbed water evaporates back into the air. The water content of the near-surface layers settles at the desired value, but the lower-lying levels fall below the intended value. It is therefore prudent to slightly extend the time in the water bath and then store the part in normal room air for several days of conditioning. After the loss of water from the near-surface layers this achieves virtually uniform water content over the cross section.

3.2 Important factors in the water absorption of polyamides

The process of water absorption is generally only very slow and is influenced by various factors. The most important factors can be illustrated as follows:

3.2.1 Speed of water absorption

Water or moisture is absorbed very slowly by polyamide until a state of equilibrium is achieved. Once equilibrium is reached moisture content can only be influenced by altering the environmental conditions, such as increasing the moisture content and/or increasing the temperature. The tendency of water molecules to diffuse into a solid increases significantly with increasing temperature. It therefore follows that, with increasing ambient temperature, less time is required to make a defined amount of water penetrate into a part made of polyamide. The size of the specific surface area (surface area per unit volume) is crucial. The larger the specific surface area of a part is, the larger the surface area available for attack by the water molecules and the resulting absorption speed is faster. It may be concluded from the above that for the practical use of polyamides short-term fluctuations in humidity in the environment have only a limited impact on the material properties, but that long-term fluctuations and possibly associated with high temperature can induce the changes in material properties previously described.

3.2.2 Water absorption in air

Water absorption due to humidity is primarily determined by the relative humidity and not the air temperature. It should be noted that the process of water absorption due to humidity only takes place in the near-surface areas of thick-walled components and water absorption in the core of the part with the consequences described is normally not expected. (Fig.2)

Fig. 2 Moisture distribution in thick-walled components from cast polyamide

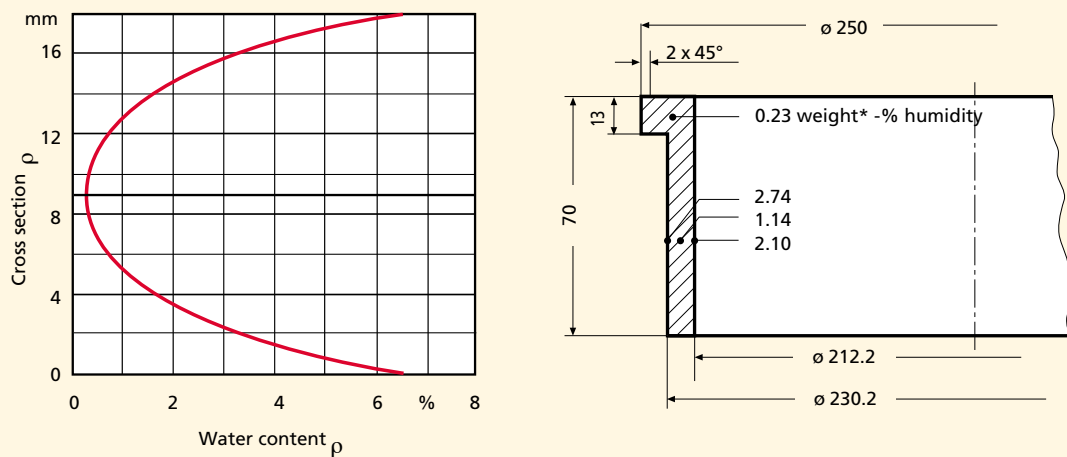

3.2.3 Influence of the degree of crystallinity

Since water is absorbed only by the amorphous proportions in the polyimide, the water intake also significantly depends on the degree of crystallinity. With increasing crystallinity the saturation concentration (depending on the chemical composition and the type of polyamide) as well as the absorption speed and the absorption capacity also increase. Cast polyamides have a higher degree of crystallinity compared to extruded polyamides. They absorb much less water and require significantly more time.

Machining guidelines

Machining and post-machining processes

4. Tempering

The tempering process is defined as the heat treatment of parts or semi-finished products in order to

- largely reduce residual stresses from the manufacturing or production process
- increase the crystallinity and thereby to improve the mechanical characteristics of the material
- prevent warping and dimensional changes during or after machining
- improve the permanent dimensional stability

Usually semi-finished products and parts are tempered in an oven using hot circulating air. Hot oil baths using a paraffin or silicone oil base are also commonly used. The process is based on a uniform scheme regardless of the heat transfer medium used. The products are slowly and evenly heated in a heating cabinet (in the media) and brought to the material-specific tempering temperature. Once this is achieved the products are kept at this temperature for several hours. The complete warming through of the products is essential and crucial for tempering to be a success. The holding period required is dependent on the product dimensions and shape as well as its mass and is set based on these parameters. On completion of the holding period ensure that the tempered material cools to room temperature slowly, draught-free and under control. This will ensure the formation of a highly crystalline structure in the material and that only minimum residual stresses result from uneven heat losses during the cooling phase.

The temperature range for common technical plastics is usually between 130 °C and 170 °C. Some materials (such as the high-temperature plastics) require higher temperatures.

In special cases technical plastics can also be tempered at higher temperatures. However, specific process conditions must be complied with and it must be ensured that the maximum temperature is always 30 to 40 °C below the melting point. The general specification of the required heating, holding and cooling times is only possible to a very limited extent. The dependencies on product dimensions, shape and mass of the goods to be tempered are very large. For example, a large mass requires a significantly higher quantity of heat and heating period to reach full and uniform heating than a small mass. It also needs a significantly longer cooling time as the quantity of heat adsorbed is released at a slow rate due to the large mass. The following diagram clearly shows these differences using newly cast solid **LiNOTAM** rods as an example.

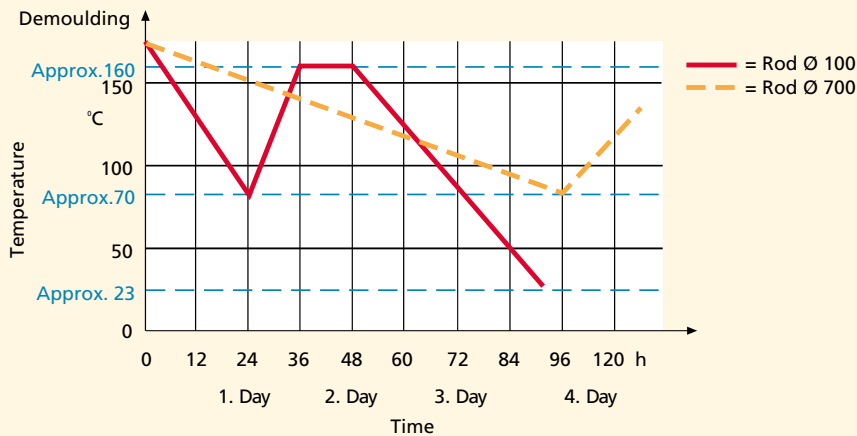

It is evident that a solid rod with Ø 100 is cooled enough to be tempered one day after demoulding. However, a solid rod with Ø 700 mm needs at least four days until it is cooled down enough for the tempering process to begin.

But also the product form has a significant influence on the tempering times. Pipes are for example completely warmed faster than solid rods because they offer a greater surface area to heat absorption due to inner and outer diameter. Accordingly these cool down faster again after tempering than solid bars.

If parts are to be intermediately tempered during manufacturing, in addition to the above parameters also the geometric conditions of the construction part as well as the existing wall thicknesses and their distribution on the workpiece are to be considered.

Taking previous versions into consideration the following data can be used as a rough guideline:

Material	Temperature in °C	Heating in °C/Hr.	Holding time in min/mm	Cooling in °C/Hr.
Polyamide (PA):	ap. 160-165	ap. 10-15	ap. 5-6	ap. 15-20
Polyacetal (POM):	ap. 150-152	ap. 10-15	ap. 5-6	ap. 15-20
Polyethylene terephthalate (PET):	ap. 170-175	ap. 10-15	ap. 5-6	ap. 15-20
Polyetheretherketone (PEEK):	ap. 220-225	ap. 10-15	ap. 5-6	ap. 15-20

More exact details for the tempering of our products are available on request.

Germany: Licharz GmbH
Industriepark Nord | D-53567 Buchholz | Germany
Telefon: +49 (0) 2683 - 977 0 | Fax: +49 (0) 2683 - 977 111
Internet: www.licharz.com | E-Mail: info@licharz.com

France: Licharz eurl.
Z.I. de Leveau – Entrée G | F-38200 Vienne | France
Téléphone: +33 (0) 4 74 31 87 08 | Fax: +33 (0) 4 74 31 87 07
Internet: www.licharz.fr | E-Mail: info@licharz.fr

Great Britain: Licharz Ltd
34 Lanchester Way | Royal Oak Industrial Estate | Daventry, NN11 8PH | Great Britain
Phone: +44 (0) 1327 877 500 | Fax: +44 (0) 1327 877 333
Internet: www.licharz.co.uk | E-Mail: sales@licharz.co.uk

USA: Timco Inc
2 Greentown Rd | Buchanan NY 10511 | USA
Phone: +1 914 - 736 0206 | Fax: +1 914 - 736 0395
Internet: www.timco-eng.com | E-Mail: sales@timco-eng.com

LICHARZ

EXACTLY YOUR SOLUTION:

We think with you from the beginning!

We offer advice on how to utilise plastics and develop your component together with you:

- we check application conditions on your machine
- we check your design drawing
- we recommend the material and the process
- we manufacture a prototype for you if required

You will receive your product quickly and economically, exactly as you need it!



nominal charge 18.00 Euro